



"Serving Those Who Serve The Very Best"

Users Manual

SAFE & EASY® FILTER 34x24

READ AND SAVE THIS MANUAL FOR FUTURE REFERENCE.

RECORD THE MODEL AND SERIAL
NUMBERS OF THIS SAFE & EASY® 34x24
FILTER IN THE SPACES PROVIDED.

SERIAL NO. _____
MODEL NO. _____

KEEP THESE NUMBERS FOR FUTURE REFERENCE.

IMPORTANT: Keep a copy of your bill of sale. The date on the bill establishes the warranty period should service be required. If service is performed, it is in your interest to obtain and keep all receipts. Keating commercial filters are not intended for household use.

The Owner's Guide provides specific operating instructions for your model. Use the Safe & Easy® 34x24 Filter only as instructed in this Owner's Guide.

VERSIÓN EN ESPAÑOL: Si desea obtener una copia en español de este Manual de el Usuario, sirvase escribir a la dirección que se incluye a continuación.

CONTENTS:

SECTION A: PREPARING THE FILTER DRAWER

REMOVING THE FILTER	1
INSTALLING COMPONENTS	1
CONNECTING THE FILTER ASSEMBLY	1-2

SECTION B: PREPARING THE OIL FOR FILTRATION

OIL TEMPERATURE	2
REMOVING THE SCREEN	3

SECTION C: FILTRATION

DRAINING OIL	2
RETURNING THE OIL	2-3
RINSING THE FRYER	2-3

SECTION D: CLEAN UP

INSTRUCTIONS	3
DRAIN VALVE HANDLE PLACEMENT	3

SECTION E: DISCARDING THE OIL

PREPARING THE FILTER	3
CONNECTING THE DISCARD HOSE	3-4
INSTRUCTIONS	4
FILTER SIDE VIEW	4

PARTS LIST

.....	5
-------	---

SELF HELP GUIDE & QUICK HINTS

QUICK HINTS	6
PROBLEM/SOLUTIONS	6-7
PREVENTATIVE MAINTENANCE	7

WIRING DIAGRAM

.....	8
-------	---

***AS CONTINUOUS PRODUCT IMPROVEMENT OCCURS, SPECIFICATIONS MAY BE CHANGED WITHOUT NOTICE.**

Keep this manual for training new personnel.





34x24 SAFE & EASY FILTER OPERATING INSTRUCTIONS

A. PREPARING THE FILTER-DRAWER

CAUTION

WATER IN ANY FORM & HOT OIL DON'T MIX!

NOTE: Operator should be outfitted with proper protective attire: safety goggles, oil and heat resistant gloves, apron and footwear

Filter assembly inside of cabinet:

1. Disconnect the power cord from electrical outlet.
2. Pull the handle marked "Pull to Release Filter" (top of filter panel).
3. Remove the entire assembly from the cabinet by rolling it forward.
4. Ensure all components are clean (NOTE: Components are dishwasher safe).
5. Install components into tub as follows:
 - a. Sump screen
 - b. Filter paper
 - c. Hold down ring (Note 1)
 - d. Acidox (1 package per 40lbs oil) (Note 2)
 - e. Crumb basket

See Figure 1

NOTE: Hold down ring makes a gasket-like seal on filter paper. Filter paper must be placed edge to edge from front to back, overlapping on sides. Filter paper must be smooth and flat under hold down ring to get a proper seal. Lock the two tension arms into place (push down and rotate 90°).

NOTE: One package of Acidox is needed for every 40 pounds of oil.

See Figure 2

Side View of Filter

6. Remove crumb basket and set aside.
7. Sprinkle Keating Acidox Powder evenly over the paper.
8. Replace crumb basket and push drawer fully into cabinet. Ensure the connection on top of the housing mates with the connection inside the cabinet. NOTE: If the fryer has casters, the casters must be straight in order for the filter to be pushed into the cabinet.

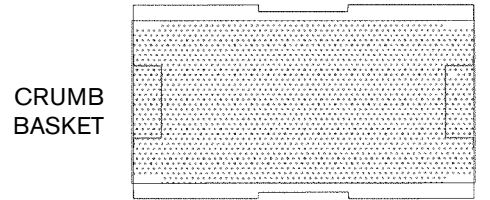

SPRINKLE ACIDOX EVENLY ON PAPER

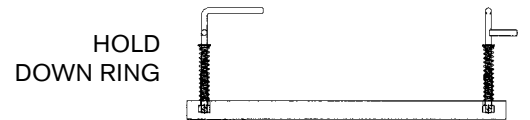

FILTER PAPER

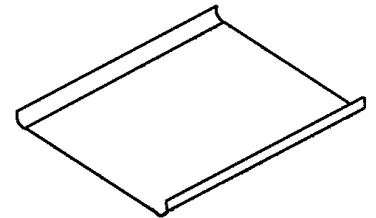

SUMP SCREEN

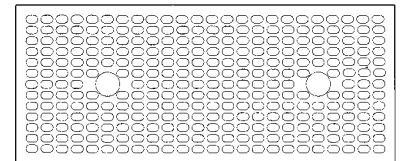

FIGURE 1.

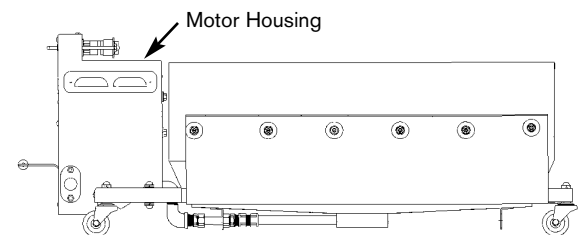

FIGURE 2.

KEEP THIS MANUAL FOR TRAINING NEW PERSONNEL

Pull the front of the filter system lightly to verify proper connection

NOTE: Cabinet door should be closed during filtration.

NOTE: For best results, new filter paper and Acidox Powder must be used for each fryer.

B. PREPARING OIL FOR FILTRATION

NOTE: Oil in fryer must be between 250° - 350°F.

1. Turn fryer completely off.
2. Remove screen from over tubes/element with tongs or a Drain Clean Out Rod. Refer to Figure 3.

CAUTION

Screen over tubes will be very hot and should be moved to a safe place.

3. Use spoon provided to stir oil. Bubbling will occur until all water is removed. Failure to do so will clog the filter paper. Refer to Figure 4.

NOTE: Water settles in the cooler oil in the Cold Zone. If the water is not removed, the filter paper absorbs the water preventing the oil from passing through it.

C. FILTRATION

1. On filter assembly, have handle with the black knob set to oil to fryer. Refer to Figure 5.
2. Open the drain valve slowly by lifting and then pulling the drain valve handle and drain fryer (handle with largest black knob).

NOTE: A Drain Clean Out Rod may be needed to loosen any solid residue. Use it only when valve is fully open.

3. Wipe crumbs from splashdeck while fryer is empty. Plug the motor into the outlet.

NOTE: On units with more than one fryer or a separate cabinet for the filter system, you must open the return valve handle (small black knob next to drain handle) by pulling it forward. This will allow the oil to pump into the correct fryer.

4. On the filter panel, turn the pump switch to the "ON" position. The green light will illuminate. Refer to Figure 5.

NOTE: If oil does not return to fryer, check the following:

1. Filter tub setup (See Fig. 1)
2. Figure 4 (Water may have clogged the paper)
3. Return valve for units with more than one fryer or separate filter cabinet is not opened.

5. Let the pump run with drain valve open to remove crumbs and residue from the bottom of fryer and the drain lines. Failure to do so may cause the drain lines to clog up.

NOTE: If the pump shuts down, turn it off and let the motor cool. Push the motor reset button located on the filter panel. Check filtering procedure or clean tub and paper if needed.

6. Let swirling action rinse down fryer.

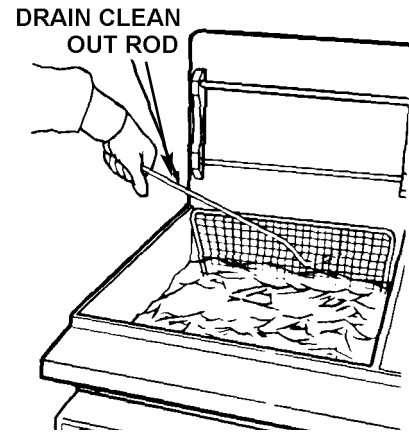

FIGURE 3.
REMOVE SCREEN OVER
TUBES/ELEMENTS

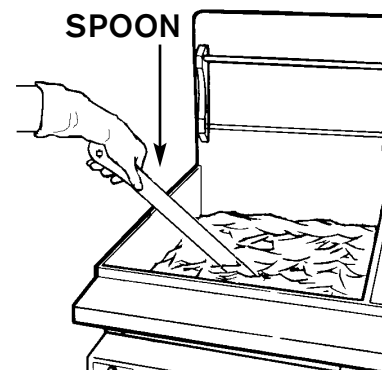

FIGURE 4.
STIR WITH SPOON PROVIDED TO
REMOVE WATER

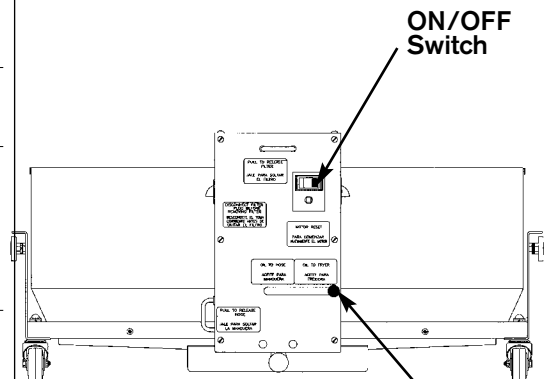

FIGURE 5.
FRONT VIEW OF FILTER

- Fully drain fryer.

NOTE: Pump should be run for at least 30 seconds after crumbs are removed from fryer. This will help prevent blockage in the drain lines.

- Close drain valve by pushing in the large black knob and locking it into place and completely refill fryer. Refer to Figure 6.

NOTE: The drain valve handle controls fryer's Main Power Switch. If drain valve is not fully closed and locked, fryer will not operate. See Figure 6.

- Turn pump switch to the "OFF" position 10 seconds after bubbles appear in the fry vat. Close return valve by pushing in the small black knob completely, after turning OFF the pump switch (for units with more than one fryer or central filter). See Figure 7.

D. CLEAN UP

⚠ WARNING

Filter drawer and pipes will remain hot following filtration. Allow the unit to cool down before clean up. Failure to do so may result in serious injury to the operator.

See 1-5 on page 1.

- Remove crumb basket.
- Push down on the 2 tension arms on the hold down ring, rotate 90°, and remove.
- Remove the used filter paper and discard.
- Remove sump screen.
- Thoroughly clean the entire filter tub and all components.

NOTE: Components are dishwasher safe.

- Prepare drawer for next use (see section A "Preparing the Filter Drawer").

NOTE: Instructions for cleaning the fryer are in the Operating Section of the Fryer Service Manual.

E. DISCARDING THE OIL

NOTE: The 6 foot hose provided with the filters should be used to discard the oil ONLY. DO NOT USE FILTER ASSEMBLY TO TRANSPORT HOT OIL.

- Prepare the filter drawer (see section A).
- Prepare the oil (see section B).
- Connect the hose to the right side of the filter assembly in the front. See Figure 8.
- Push the small black knob on the filter panel to the left ("Oil to Hose").
- Place the nozzle of the hose in an approved discard container.
- Drain the oil.
- Plug the filter into the receptacle.
- Turn the motor switch ON (the green light will illuminate).

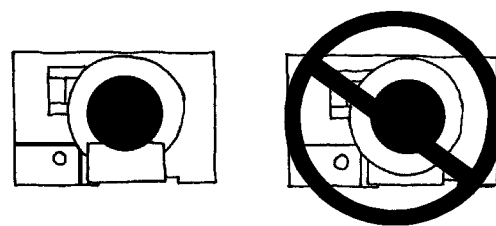
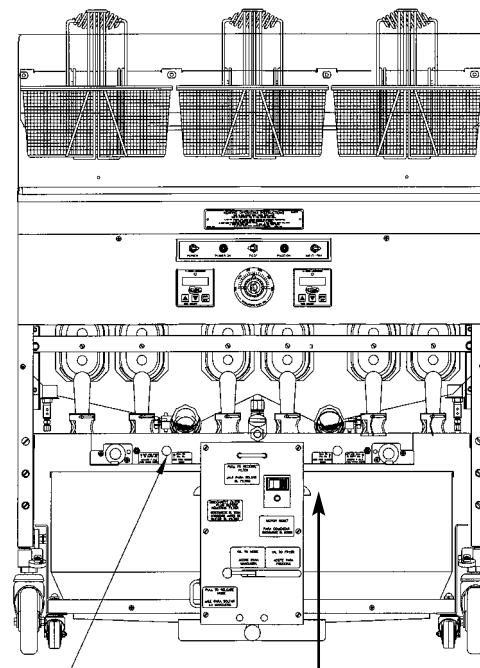

FIGURE 6.



Return valve (small black knob) must be pulled to open when filtering and pushed closed when complete.

FIGURE 7.

34x24 Fryer with Safe & Easy Filter.

CAUTION

A KEATING FRYER OR FILTER SHOULD BE DRAINED ONLY UNDER THE SUPERVISION OF PROPERLY TRAINED PERSONNEL. WHEN DISCARDING OIL, A COVERED RECEPTACLE APPROVED FOR USE WITH HOT OIL SHOULD BE USED. USE OF A NON-APPROVED RECEPTACLE OR METHOD OF DRAINING THE OIL COULD JEOPARDIZE THE SAFETY OF THE OPERATOR.

NOTE: Keep the pump turned "ON" until bubbles occur in the discard receptacle. Allow the pump to run an additional 15 seconds to clear all pipes.

9. Turn the motor switch "OFF".
10. Push the small black knob on the filter panel to the right ("Oil to Fryer").
11. Close drain valve of the fryer (large black knob).
12. Hose can be removed by pulling the handle on the left of the motor housing.
13. Prepare filter tub for next usage (see section A).
14. Clean excess oil from wand and quick disconnect on the hose.

CAUTION

To avoid damaging the fryer, do not power wash, spray or hose it down while cleaning it.

Pump must be primed with oil after boil-out with water.

Failure to lubricate pump may cause severe damage to Filter System and void the warranty.

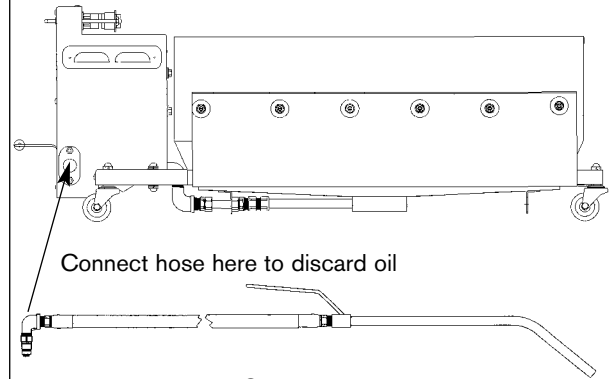

FIGURE 8.

CAUTION

HOT FLUID. DO NOT FILL BEYOND MAXIMUM FILL LINE LOCATED IN THE FRYER VESSEL.

WARRANTY REPAIRS

Keating's warranty begins with the date of installation. In the event that your Filter, under warranty, needs repairs other than routine cleaning, you are requested to contact KEATING OF CHICAGO, INC. (1-800-KEATING) before calling a local service company.

ORDERING PARTS

Parts may be ordered by part number by calling your local service company, Keating at 1-800-KEATING, or At our on-line store at www.keatingofchicago.com.

Refer to the Keating Safe & Easy Filter Limited Warranty for warranty service information.

The model/serial plate is located on the back of the motor housing. The serial and model numbers are necessary when ordering.

WARNING AND OPERATING PLATES

All warning and operating plates on the Keating Safe & Easy Filter should be in place at all times.

34x24 SAFE & EASY FILTER PARTS LIST

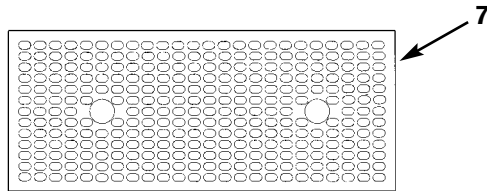
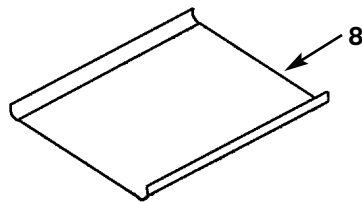
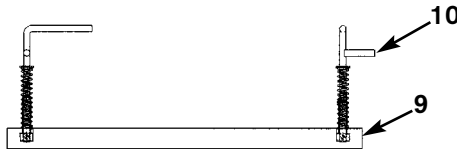
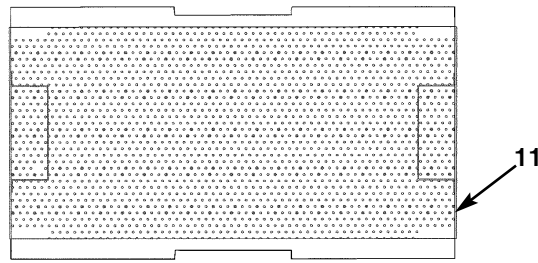

Components are not shown to scale

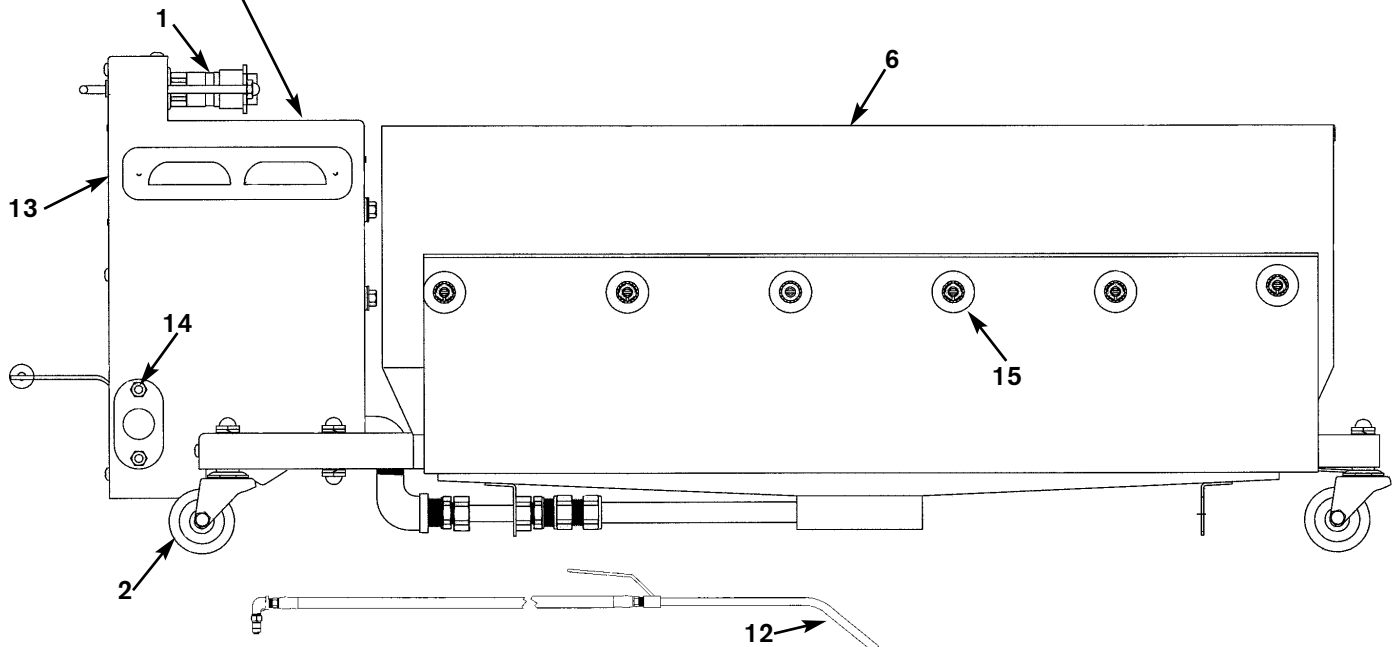
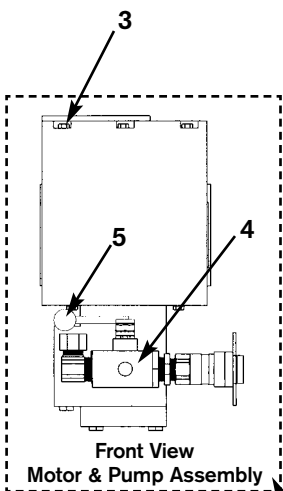

Description	Part No.
1. Quick Connect Coupler	052573
Compression Fitting Straight	011087
2. Caster Swivel 2"	054919
3/8-16 Acorn Nut	011763
3/8 Split Lockwasher	009085
3. Motor & Pump	038176
4. Three way valve	009354
5. Knob Black	031532
6. Filter Tub	Call 1-800-KEATING
7. Sump Screen 34x24"	056499
8. Filter Paper SE 34X24"	053852
9. Hold Down Ring 34x24"	056501
10. Hold Down Ring Handle	052817
Spring	006656
Collar	000512
11. Crumb Basket 34x24"	056502
12. Hose Assembly 6'	054031
13. ON/OFF switch (Not Shown)	015119
14. Quick Connect Handle to Hose (Not Shown)	053438
Acorn Nut	015159
15. Roller	000520
16. Power Cord	055227

Self-Help Guide

PROBLEM	PROBABLE CAUSE	SOLUTION (Follow Sequentially)
Motor runs but will not pump oil.	Tub not set up properly.	Place components in tub per the following: <ol style="list-style-type: none"> 1. Sump screen on the very bottom 2. Filter paper over sump screen (Lie it flat on the bottom, creasing the sides). 3. Hold down ring (ensure paper is not folded, lock hold down ring into place ensuring a tight seal). 4. Sprinkle Acidox Powder evenly over filter paper (1 bag per 40 lbs. of oil). 5. Crumb basket for large debris.
	Filter not connected inside of cabinet	<ol style="list-style-type: none"> 1. Ensure filter assembly is rolled straight onto the rails inside of the cabinet. 2. Push filter assembly back as far as possible 3. Ensure quick disconnect fitting on top of filter connects automatically with quick connect fitting inside of cabinet. 4. Pull on filter lightly to ensure a tight connection
	Valve not switched to "Oil to Fryer"	<ol style="list-style-type: none"> 1. Set the black knob in the middle of the filter control panel to the far right. 2. Try to filter again.
	If there's more than one fryer, return valve not open.	<ol style="list-style-type: none"> 1. Open the door of the fryer you wish to filter. 2. Pull the return valve handle (small black knob) out as far as possible. 3. Attempt to filter again. When completed, push the black knob in as far as possible to close.

Quick Hints

<p><u>Do's</u></p> <ol style="list-style-type: none"> 1. Read and follow the filtering procedure. 2. Always verify 1 connection is engaged when filtering. <ul style="list-style-type: none"> • Quick disconnect on top of the motor housing to the fryer or central filter quick disconnect. 3. Stir the oil completely before draining. 4. Place the sump screen under the filter paper. 5. Change the filter paper for each fryer filtered. 	<p><u>Don'ts</u></p> <ol style="list-style-type: none"> 1. Run water through the pump. 2. Filter oil without wearing the proper attire. 3. Filter cold oil (must be between 250°- 350°). 4. Use the 6 foot hose to clean the fry tank (hose should only be used to discard the oil). 5. Powerwash, spray, or hose down the motor housing area, as electrical components are present.
--	--

Self-Help Guide (Continued)

PROBLEM	PROBABLE CAUSE	SOLUTION (Follow Sequentially)
Motor runs but will not pump oil.	Oil has not penetrated the filter paper	<ol style="list-style-type: none"> 1. Let oil sit in the filter pan for approximately 2 minutes and try again.
Motor not making any noise	<p>Not plugged in</p> <p>Motor has overheated</p>	<ol style="list-style-type: none"> 1. Plug filter into the receptacle inside of cabinet 2. Turn ON/OFF switch to 'ON'. <ol style="list-style-type: none"> 1. Allow motor to cool for approximately 10 minutes. 2. Press the reset button near the ON/OFF switch on the filter control panel and try again.
Oil not pumping through the hose	Valve not switched to "Oil to Hose"	<ol style="list-style-type: none"> 1. Set the black knob in the middle of the filter control panel to the far left.

PREVENTIVE MAINTENANCE: Familiarize yourself with the proper filtering procedure prior to attempting to filter

1. To remove water, stir oil until bubbling stops; water will clog filter paper pores.
2. Verify all connections, especially quick disconnect (inside fryer or CF cabinet) are tight; not leaking oil or sucking air.
3. Use only one sheet of filter paper properly sealed under hold down ring.
4. Use a drain clean out rod if partial or full blockage in fryer drain is suspected.
5. If filter was used for fryer boil out, run oil through filter to lubricate motor/pump.
6. Clean filter and all components after each use. Do not permit oil to remain in filter drawer; it will clog the pump.
7. Verify all lights and controls operate.
8. Adhere to operating instructions in sequence given for proper filtration.
9. Prepare filter for next use by using new filter paper and Acidox Powder for each fryer.

WIRING DIAGRAM

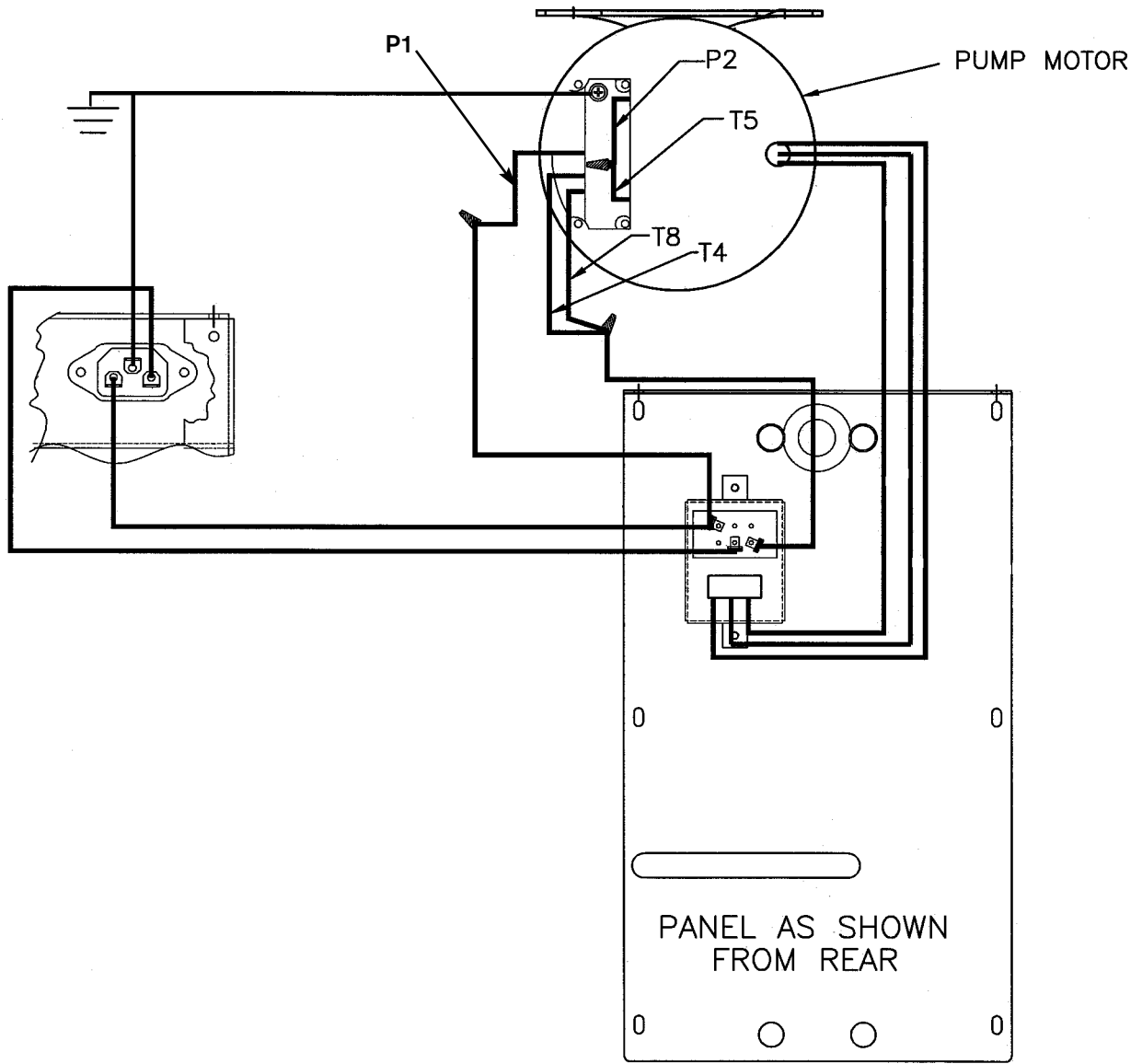

If you have any questions regarding filtering procedures or need assistance, call: **1-800-KEATING.**



KEATING OF CHICAGO, INC.
8901 West 50th Street, McCook, Illinois 60525-6001
Toll Free 1-800-KEATING
TEL 708-246-3000
FAX 708-246-3100
www.keatingofchicago.com



WARRANTY

LIMITED WARRANTY

Keating of Chicago, Inc. ("Keating") warrants to the original purchaser ("Customer"), all new Keating Fryers, Filter Systems, Griddles, Keep Krisp® Custom Pasta Systems, Top-Side™ Cookers, Computer Timers, Fryer & Pasta Vessels and Keating replacement parts ("products") installed after June 1, 1994 to be free to defects in material or workmanship, subject to the following terms and conditions.

LENGTH OF WARRANTY

All products other than Fryer & Pasta Vessels and replacement parts shall be warranted for a period of one year from the date of original equipment installation. Keating replacement parts are warranted for a period of ninety days from the date of installation. Fryer & Pasta Vessels are warranted as described below.

FRYER & PASTA VESSEL WARRANTY

Fryers purchased after June 1, 1994 carry a prorated vessel warranty on defects in materials or workmanship to the Customer based on the following scale:

Time from Installation Date	Fryer Vessel Warranty Credit
13-60 months	100%
61-72 months	80%
73-84 months	60%
85-96 months	40%
97-108 months	20%
109-120 months	10%

The credit for the defective fryer & pasta vessel shall be applied against the cost of the replacement vessel, utilizing Keating's then current price, upon return of the vessel to Keating, (freight to be paid by Keating within the first 2 months only), only during the first 60 months, subject to the limitations described below.

LIMITATIONS OF LIABILITY

In the event of warranty claim or otherwise, the sole obligation of Keating shall be the repair and / or replacement at the option of Keating of the product or component or part thereof. Such repair or replacement shall be at the expense of Keating except that the Customer shall pay the following expenses: all freight and labor expense for Keating replacement parts; for all other products, mileage exceeding 50 miles or travel more than one hour, labor costs of more than one person, overtime rates, truck charges, difference between ground and other mode of transportation, and holiday charges. Any repair or replacement under this Limited Warranty does not constitute an extension of the original warranty for any period for the product or for any component or part thereof. Parts to be replaced under this Limited Warranty will be repaired at the option of Keating with new or functionally operative parts. Keep Krisps and Computer Timers must be returned to Keating for warranty repair or replacement. Field repairs of those items are not authorized.

THE LIABILITY OF KEATING ON ANY CLAIM OF ANY KIND, INCLUDING CLAIMS BASED ON WARRANTY, EXPRESSED OR IMPLIED, CONTRACT, NEGLIGENCE, STRICT LIABILITY OR ANY OTHER THEORIES SHALL BE SOLELY AND EXCLUSIVELY THE REPAIR OR REPLACEMENT OF THE PRODUCT AS STATED HEREIN, AND SUCH LIABILITY SHALL NOT INCLUDE, AND CUSTOMER SPECIFICALLY RENOUNCES ANY RIGHTS TO RECOVER, SPECIAL, INCIDENTAL, CONSEQUENTIAL OR OTHER INJURIES TO PERSONS OR DAMAGE TO PROPERTY, LOSS OF PROFITS OR ANTICIPATED PROFITS, OR LOSS OF USE OF THE PRODUCT.

If any oral statements have been made regarding the Keating products, such statements do not constitute warranties and are not part of the contract sale. This Limited Warranty constitutes the complete, final and exclusive statement with regard to warranties.

THIS LIMITED WARRANTY IS EXCLUSIVE AND IS IN LIEU OF ALL OTHER WARRANTIES WHETHER WRITTEN, ORAL, STATUTORY OR IMPLIED, INCLUDING BUT NOT LIMITED TO ANY WARRANTY OF MERCHANTABILITY OR FITNESS FOR PARTICULAR PURPOSE OR WARRANTY AGAINST LATENT DEFECTS.

EXCLUSIONS

The warranties provided by Keating of Chicago, Inc. do not apply in the following instances:

1. Defects arising out of or resulting from improper installation or maintenance, abuse, misuse, modification or alteration by unauthorized service personnel, or any other condition not attributable to a defect in material or workmanship. Proper installation and maintenance are the responsibility of the installer and Customer, respectively. Proper installation and maintenance procedures are prescribed by the Keating Service Manual.
2. In the event that the product was damaged after leaving the factory due to flood, fire, other acts of God or accident, damage during shipment should be reported to the carrier and is not the responsibility of Keating.
3. In the event the serial number or rating plate has been removed from the product or altered.
4. On parts which would normally be worn or replaced under normal conditions, including but not limited to electric bulbs, fuses, interior and exterior finishes, gaskets and radiants.
5. With regard to adjustments and calibrations such as leveling, tightening of fasteners or plumbing connections, improper gas pressure or improper electrical supply, the checking of and changes in adjustment and calibrations are the responsibility of the installer. Proper installation procedures are prescribed by the Keating Service Manual.
6. In the event of unauthorized repairs or alterations to the Keating product.
7. With the use of sodium chloride in pasta vessels or harsh chemicals in fryer or pasta vessels.
8. Installation in Household.

OTHER TERMS AND CONDITIONS

The Customer must provide proof of purchase from Keating.

This Limited Warranty is valid in the 50 United States, its territories, and Canada, and is void elsewhere.

Keating products are sold for commercial use only. If any Keating product is sold as a component of another product or used as a consumer product, such Keating product is sold As Is without any warranty. If any provision of this Limited Warranty is held to be unenforceable under the law of any jurisdiction, such provision shall be inapplicable in such jurisdiction, and the remainder of the warranty shall remain unaffected. Further in such event, the maximum exclusion or limitation allowable under applicable law shall be deemed substituted for the unenforceable provision.

This Limited Warranty shall be governed by and construed in accordance with the laws of the State of Illinois.

TO SECURE WARRANTY SERVICE

All repair services under this Limited Warranty must be authorized by Keating or performed at Keating. Authorization may be obtained by calling 1-800-KEATING within the Continental United States, Alaska, Hawaii, Puerto Rico and Canada during normal business hours (8 a.m. through 5 p.m. Central Time, Monday through Friday). When calling, please have the following information available: (1) name, address and telephone number of the Customer; (2) location of product; if different; (3) name, model number and serial number of the product; (4) installation date; and (5) description of defect. Keating will then issue a service authorization work order number to one of its approved independent servicing organizations, or request the product or part be shipped to Keating for repair or replacement, as appropriate. Any defective part subject to a claim under this Limited Warranty must be shipped freight prepaid to Keating for testing and examination. Keating's decision as to the cause and nature of any defect under this Limited Warranty shall be final.

SERVICE INFORMATION

If you have a service related question call 1-800-KEATING.
Please state the nature of the call; it will ensure speaking with the appropriate person.
Have your serial and model number available when ordering parts.

KEATING OF CHICAGO, INC.

8901 West 50th Street, McCook, Illinois 60525-6001

Phone: (708) 246-3000 FAX: (708) 246-3100

Toll Free 1-800-KEATING (In U.S. and Canada)

www.keatingofchicago.com

***As continuous product improvement occurs, specifications may be changed without notice.**

KEATING LIMITED WARRANTY CARD

PLEASE COMPLETE AND MAIL AT ONCE—WARRANTY IS NOT IN EFFECT UNTIL CARD IS RETURNED

COMPANY: _____

ADDRESS: _____

CITY: _____ STATE: _____ ZIP: _____

DEALER: _____

DATE OF PURCHASE: _____ INVOICE NUMBER: _____

SERIAL NUMBER: _____ FRYER FILTER SYSTEM GRIDDLE

REMARKS: _____ TOP-SIDE COOKER HOT PLATE PASTA PLUS

I HAVE READ THE INSTALLATION AND OPERATION INSTRUCTIONS.

SIGNED: _____ DATE: _____

"Serving Those Who Serve The Very Best"